

AC and DC Reactors for Filtering of Harmonic Currents

Introduction

Variable frequency drives have been used in industrial applications for years because of their ability to provide precise process control. They have also become the standard method of controlling heating, ventilation and air conditioning (HVAC) systems due to their precise control which results in significant energy savings.

In most installations today, there is a large installed base of sensitive electronic equipment such as medical equipment, radios, PLC's, TV's and clocks. When the system is part of an airport, hospital, or research facility, the amount of sensitive equipment increases dramatically. This imposes specific requirements on the variable frequency drives which are used in public and semi-public systems as opposed to drives which are installed in dedicated environments.

This note will examine one aspect of electrical noise generated by variable frequency drives, i.e. harmonic distortion of the AC power line. The causes and effects of this noise will be discussed and some of the considerations that should go into the selection of a variable frequency drive will be examined.

Causes of Power Line Distortion

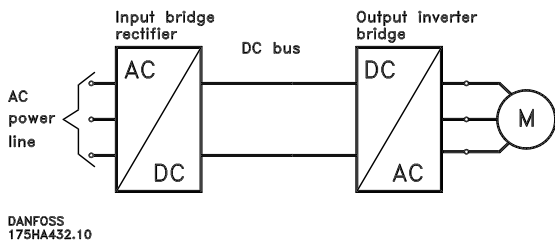

Figure 1: General block diagram of a variable frequency drive.

Most variable frequency drives operate by using a bridge rectifier to convert the incoming AC voltage into a DC voltage. The inverter of the drive then converts the DC voltage into a controlled voltage and frequency for speed control of the motor.

For the most common types of drives in use today, a diode bridge rectifier is used to convert the AC power line into a fixed-voltage DC bus. A DC bus capacitor bank is then used to filter out the AC ripple.

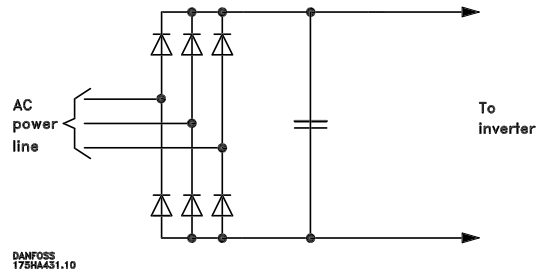

Figure 2: Diode bridge rectifier on a PWM drive.

While this results in a very efficient drive, it can cause problems with the AC power line, because of the way it draws AC current. Current cannot flow from the rectifier into the DC bus before the input voltage is greater than the DC bus voltage. As shown in figure 3, this only happens for a very short period of time for each phase. In order to transfer the energy required by the motor in such a short period of time, the peak current must be high.

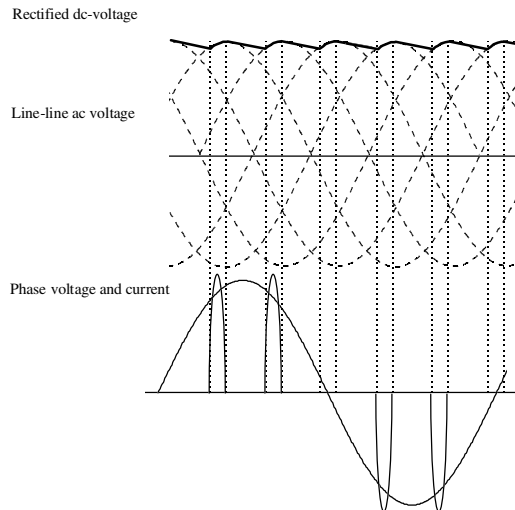

Figure 3: An input current only flows when the input voltage is greater than the DC bus voltage.

The input current is clearly seen to be non-sinusoidal. It consists of two discrete pulses per half-period. Such a current wave form has a high level of harmonic distortion. The current pulses are centered in the voltage period and the displacement power factor is therefore almost one.

Most modern electronic equipment uses this type of a bridge rectifier power supply. This includes computers, fax machines, copy machines, and electronic lighting ballasts as well as VFDs. Because the current is not proportional to the supplied voltage, such loads are called non-linear loads.

■ Measuring Power Line Distortion

The severity of the voltage distortion will vary with the impedance of the building's electrical power distribution system and the number and type of non-linear loads connected. The level of voltage distortion that is acceptable depends on the sensitivity of the other equipment which is installed in the building. In order to compare these two distortion levels, it is necessary to be able to quantitatively describe distortion. Harmonic analysis is used to provide this description.

The theory of harmonic analysis states that any repetitive wave form can be mathematically described as a series of pure sine waves. These sine waves consist of a fundamental frequency and integer multiples of that frequency, called harmonics. There are two ways in which the results of this mathematical analysis can be expressed.

The most detailed method describes the amplitude of each individual harmonic component, either in absolute units (such as volts) or as a percentage of the fundamental component. With this, it is possible to determine the source of harmonic distortion. For example, in balanced electrical systems, the only harmonics that can be generated by symmetrical three phase loads are those that are not multiples of 2 or 3 (the 5th, 7th, 11th, 13th and similar harmonics). If a third harmonic is present in the system, it is probably the result of single phase loads or phase imbalances. The detailed analysis of the harmonics in a system also helps when designing specific filters for solving harmonic distortion problems.

For a more simplified view, total harmonic distortion is often used. As a percentage, this single number is calculated by adding the square of each relative harmonic value and taking the square root, as shown in figure 4.

$$THD = \sqrt{\sum_{n=2}^{\infty} \left(\frac{H_n}{H_1}\right)^2} \cdot 100\%$$

Figure 4: Formula for calculating total harmonic distortion (THD), where H_n is the amplitude of each individual harmonic.

■ Harmonic Distortion Limits

Harmonic voltage distortions can affect the operation of other devices connected to the same power grid, therefore various standards have been devised to judge the severity of harmonic distortion. One of these is IEEE 519 by the American Institute of Electrical and Electronic Engineers. This standard recognises that the sensitivity of the equipment in a building determines the acceptable level of voltage distortion. IEEE 519 therefore states different limits for different types of buildings. As can be seen from figure 5, the requirements which apply to factories and other industrial applications are much less stringent than the requirements for buildings where the majority of HVAC systems are installed. Therefore, variable frequency drives do not always include harmonic filtering, but in HVAC drives it is required.

Application Class	THD (%)
Sensitive Applications <ul style="list-style-type: none"> • Airports, Hospitals • Telecommunication Facilities 	3%
General Applications <ul style="list-style-type: none"> • Office buildings, Schools 	5%
Dedicated Systems <ul style="list-style-type: none"> • Factories 	10%

Figure 5: IEEE 519 standards for total harmonic voltage distortion.

The British Electricity Council Engineering Recommendation G5/3 also sets the standards for acceptable voltage distortion. Here an overall level of 5% THVD is applied.

Both of the above mentioned standards limit harmonic voltage distortion in the system and since voltage distortion depends on the total non-linear load and the system impedance, these levels cannot be applied to individual equipment.

Current distortion on the other hand is equipment specific and requirements for maximum levels can be applied to individual loads. When they are approved, IEC/EN 61000-3-2 (equipment below 16A) and IEC/EN 61000-3-4 (equipment above 16A) will state specific limits to individual equipment based on the short circuit ratio in the system.

IEC/EN 61000 has introduced limits to a new performance index which is called "Partial Weighted Harmonic Distortion" (PWHd) which gives high order harmonics more impact. In this standard the square of

the harmonic divided by the fundamental current has to be multiplied by the harmonic order. Further PWHd is only calculated for the 14th through the 40th harmonic current. The formula for calculation of PWHd is shown in figure 6.

$$PWHd = \sqrt{\sum_{n=14}^{n=40} n \cdot \left(\frac{I_n}{I_1}\right)^2} \cdot 100\%$$

Figure 6: Calculation of PWHd per IEC/EN 61000

Basic Three Phase Drives

In three phase systems, the actual current flows in two pulses that are 60° apart. For line 1, one pulse occurs when the voltage difference between L1 and L2 is at its maximum and a second pulse occurs when the voltage difference between L1 and L3 is at its maximum. The actual input current to a basic drive is shown in figure 7.

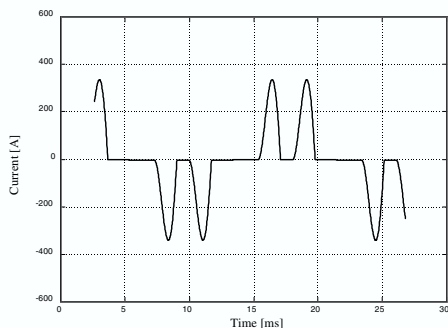

Figure 7: Input current to a basic variable frequency drive.

These short duration, high peak current pulses can cause a number of problems to the rest of the building's electrical systems.

One concern relates to the power transformers that feed the drive. Transformers are designed to handle smooth, sinusoidal current. Short current pulses like the ones shown above cause additional heating in the transformer. If the transformer is not designed to safely deal with such currents, it may overheat and fail. Where no filtering is applied, it may be necessary to double the current carrying capacity of a transformer.

In the test performed for this note, the rms input current for the drive with no harmonic filtering was 107% of the fundamental current for the drive with harmonic filtering. These tests were made using a moderately high impedance power line. If the power line's impedance was lower, this difference could

approach 175%. Clearly, this additional current could require an increase in the size of all of the devices supplying current to the drive: the wires, switch gear and transformers. This increased installation cost penalty for harmonic current distortion is often overlooked.

Figure 8 below shows how much linear load a transformer can be loaded with depending on the drive load on the same transformer. This shows, that the transformer can only be loaded to 44% of its nominal power if the drives use no harmonic filtering. This means that the transformer has to be almost twice the size.

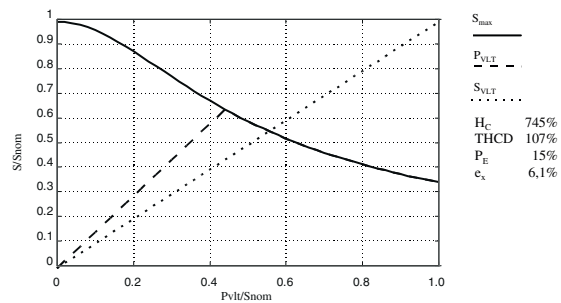

Figure 8: Distribution of linear load and drive load

A second concern is interference with other equipment. The strength of the magnetic field around a wire is proportional to the rate of changes in the direction of the current in the wire. These fast changing current pulses transmit a stronger electrical noise signal than normal sinusoidal currents. This can result in an audible hum in the other equipment in the system, unstable displays on monitors, unreliable data transmission, or interference with the operation of sensitive electronic equipment.

Thirdly such current pulses cause a more widespread and therefore more critical problem. The current is pulsating and the voltage equals current x system impedance, therefore the voltage wave form will not be sinusoidal. It will be similar to figure 9 which looks more like a trapezoid. This phenomenon is often referred to as "flat topping". Remote lighting control systems, clock synchronization systems and other similar systems, which rely on the building's electrical power distribution system to transmit information, may operate erratically because of the clipping of the voltage peaks. The voltage regulators on emergency power generators may cause unstable generator operation as they attempt to compensate for the missing voltage peaks. Other equipment, which relies on a "clean" source of power to operate reliably, may also be affected. The same voltage is used by all of

the electrical equipment connected to the circuit, therefore its effects can be quite widespread. Voltage distortion is therefore a major concern.

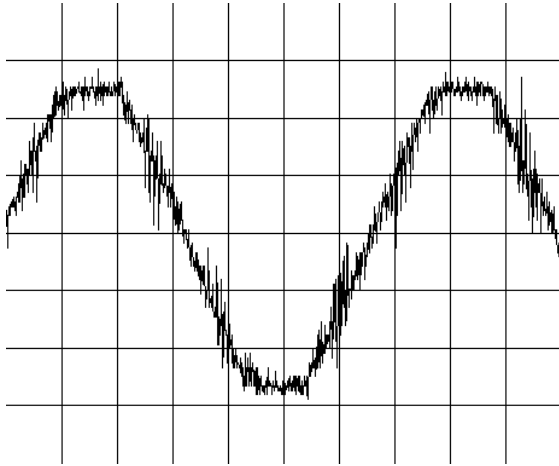

Figure 9: Phase-to-Phase Voltage distortion (“flat topping”) caused by a basic variable frequency drive.

■ Controlling Harmonic Distortion

When variable frequency drives are applied to HVAC systems, it is important to limit the harmonic voltage distortion that they cause. When a basic variable frequency drive is used in an HVAC application, this important caution is frequently overlooked. As a result, the entire building’s electrical system may suffer.

The key to controlling harmonic distortion is limiting the current pulses. This is generally accomplished through the use of coils which may also be called reactors, inductors or chokes. The inductance of a coil creates a back electromotive force (emf, or voltage) as the current pulse passes through it. This reduces the current pulsation. The input current for a drive, which includes coils in the DC bus as standard, is shown in figure 10. A comparison between this and the larger input current pulses of the basic drive, shown in figure 7 and in grey in figure 10, shows a large improvement in the wave form, although it is still not sinusoidal.

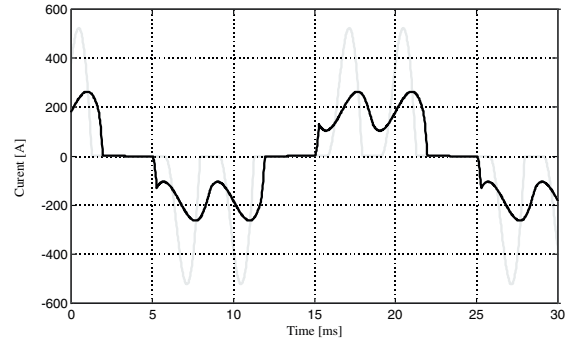

Figure 10: Input current to a drive with DC link reactors.

The table in figure 11 compares the total harmonic distortion and the true power factor measured in these tests.

	Drive with no Harmonic Filtering	Drive with DC reactors
THCD	107%	42%
True Power Factor	0.68	0.91

Figure 11: Comparison between readings of a drive with and without harmonic filters.

The graph in figure 12 shows the amplitude of each harmonic current.

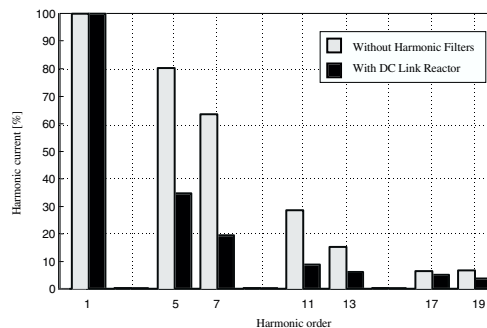

Figure 12: Comparison between the harmonic current spectrum caused by a drive with and without harmonic filters.

The important concern is of course the voltage distortion. Figure 13 shows the voltage wave form that appeared when a drive with a DC link filter was connected to the same power line and the same load as an unfiltered drive. Note the lack of any significant „Flat topping“ of the voltage wave form.

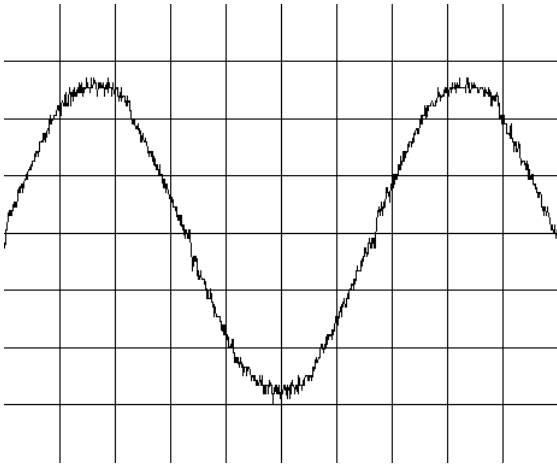

Figure 13: Input voltage to a drive with DC link reactors.

The total harmonic voltage distortion for the basic drive in figure 9 was measured to be 4 % which would be unacceptable for critical applications. For the drive in figure 13 using DC reactors, it was measured to be 2% which meets even the most stringent IEEE standard. The true power factor was found to be 0.68 when using the basic drive and 0.91 when using the drive with DC reactors.

Types of Harmonic Filters

There are two fundamental places where harmonic reducing reactors can be added to a variable frequency drive.

Figure 14 shows the design of Danfoss VLT drives. This design allows drives to be installed while maintaining a low voltage distortion level. Therefore, limiting harmonic distortion on the power line was part of the design criteria. As a result, filter reactors are built into the drive. When filter reactors are connected between the input rectifier and the DC bus capacitor, they are called DC link reactors.

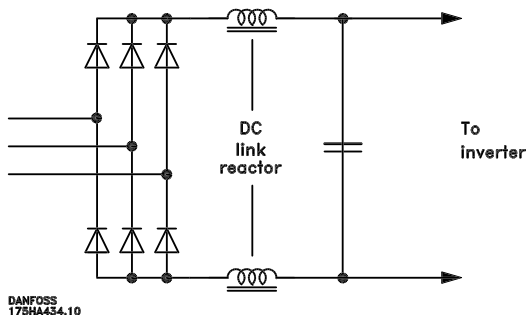

DC link reactors as standard.

When a variable frequency drive does not have harmonic filtering, it is necessary to add filtering externally before using the drive especially in HVAC, Water and light industry applications. This is the purpose of the AC line reactors which are shown in figure 15.

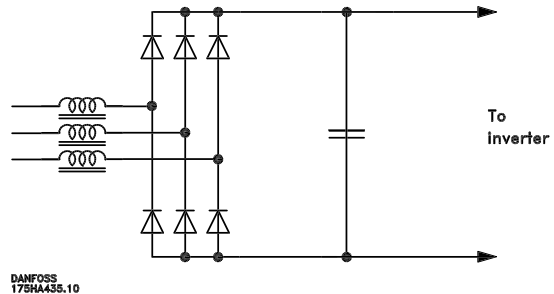

Figure 15: With a conventional variable frequency drive, AC line reactors have to be added in HVAC installations.

When passive filtering is applied, the load on the transformer can be increased significantly. Figure 16 shows that the transformer can be loaded with drives up to 71% of its nominal power, if reactors are applied which reduce the Total Harmonic Current Distortion to 42%. This can easily be achieved without influencing drive or motor performance.

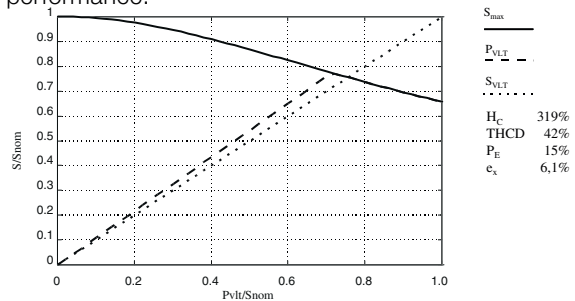

Figure 16: Maximum drive load on transformer with drive using DC reactors.

Dimensioning of fuses, contactors and cables is also influenced by harmonic currents. As an example an application including a Danfoss VLT drive which requires a 10 mm² cable, would require a 25 mm² cable if a drive without reactors had been installed instead. This is due to the increase in the harmonic currents.

■ Comparison between DC Link Reactors and AC Line Reactors

Both DC link reactors and AC line reactors can significantly reduce AC power line voltage distortion, if sized correctly.

The major advantage of AC line reactors is that they can easily be added to a drive that needs harmonic filtering. When harmonic distortion is not an issue, which is the case for many industrial applications, they can easily be omitted from the drive package and thereby reduce its cost.

It is important that the AC or DC reactors used are sized correctly to achieve the necessary harmonic performance. As shown in figure 17, the rating of the DC reactor should be approximately 50% larger than the AC line reactors per phase for them to have the same performance. If the total AC reactance is known, then the DC reactance should be approximately 50% of the AC reactance to achieve similar performance. The total AC reactance equals the size of the AC line reactor multiplied by the number of phases.

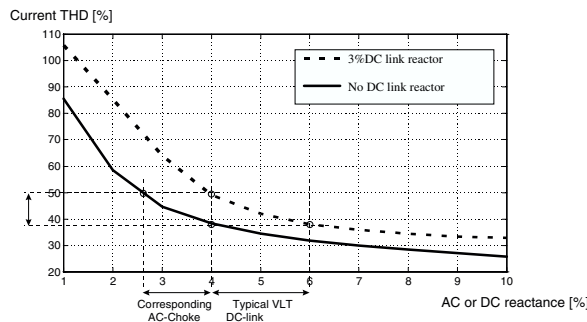

Figure 17: AC and DC reactors' impact on Total Harmonic Current Distortion

The Harmonic constant (H_C) is a performance index which can be used as an indicator of THVD independent of the system data. Figure 18 shows the relationship between H_C and TVHD.

$$THVD = H_C \cdot \frac{I_{FL}}{I_{SC}} = H_C \cdot \frac{P_{VFD}}{S_{SC}}$$

Figure 18: Calculation of THVD based on H_C

Figure 19 shows H_C as a function of the AC line impedance with no DC link reactors and with a 3% DC link reactor. Obviously performance is improved as the 3% DC reactor is added, but the AC line impedance does not have to be a reactor. This might as well be the cabling and the transformer.

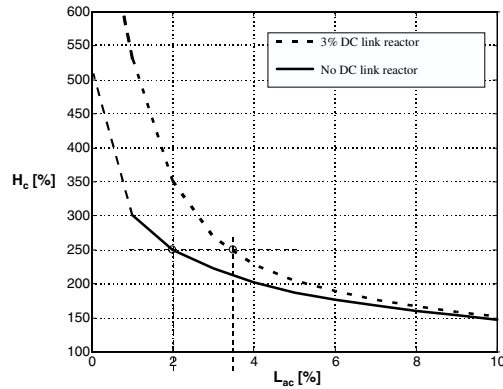

Figure 19: AC and DC reactor's impact on the Harmonic Constant

The current passing through the AC line reactors generates electrical losses which were not anticipated in the original design of the drive. These losses reduce the efficiency of the drive and result in heat generation. AC line reactors mounted below the drive add to the heat generated internally in the drive which results in a decrease in the permitted maximum ambient temperature. In addition, the voltage drop across the AC line reactors reduces the voltage available to the drive. If low line voltage problems are a concern, the addition of AC line reactors will make matters worse since a 5% AC line reactor causes a voltage drop of 2.5% in the intermediate circuit of the drive, decreasing the permitted voltage fluctuation on the mains. Since the available DC voltage drops with the AC voltage and the output power is limited by the current rating of the drive, the power which can be supplied to the motor by the drive will also decrease. DC link reactors only reduce the ripple in the intermediate circuit of the drive, they have no negative impact on the DC voltage level. This means that they do not reduce the AC voltage which can be applied to the motor either. DC reactors generate additional heat in the drive, but because the drive is designed with DC reactors, the drive is able to handle the heat generated by these reactors. Figure 20 illustrates a comparison between the AC and DC reactors' impact on the DC voltage. The top left curve is for a 1% AC reactor and the bottom left curve is for a 10% AC reactor. The curves on the right show the impact of the equivalent DC reactors.

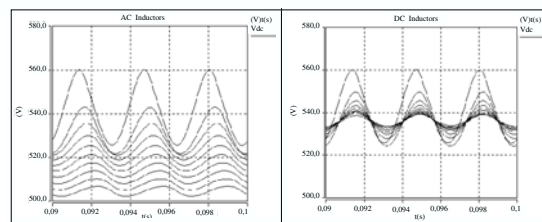

Figure 20: Impact of AC and DC reactors on DC voltage level.

AC line reactors have the advantage that they act as a buffer between power line disturbances and the drive's input rectifier section. A drive designed without AC reactors must use metal oxide varistors (MOVs) and R/C snubber circuitry to protect the drive's input from noise on the AC power line in order to obtain a similar buffer effect. Since most AC reactors are supplied as an external option and not as part of the drive design, these drives will also have to use MOV's and R/C snubber circuitry as standard to secure the protection of the drive.

Conclusion

Distortion of the AC power line by variable frequency drives is a real concern for many applications. It is important that drives provide filtering to reduce the impact that the drive might have on the rest of the electrical system. Two common methods of doing this is by means of DC link reactors and AC line reactors. Danfoss VLT drives, which have been designed with the requirements of a wide range of applications in mind, will include DC link reactors as standard.

System Data

All data in this note are based on the following system data.

Transformer Apparant Power	1.5 MVA
Primary voltage	11 kV
Secondary voltage	400 V
Impedance	6.1%
Short circuit power, secondary	25 MVA
Short circuit power, primary	350 MVA
Short circuit ratio	250
Drive input power	100 kW
H_c of Drive without filter	745%
H_c of Drive with filter	319%

The voltage is assumed to be 100% balanced. It is also assumed that before adding drives to the system, no harmonic distortion was present.

MN.90.F1.02 - VLT is a registered Danfoss trademark

Danfoss can accept no responsibility for possible errors in catalogues, brochures and other printed material. Danfoss reserves the right to alter its products without notice. This also applies to products already on order provided that such alterations can be made without subsequential changes being necessary in specifications already agreed. All trademarks in this material are property of the respective companies. Danfoss and the Danfoss logotype are trademarks of Danfoss A/S. All rights reserved.

Nomenclature

AC	=	Alternating Current [A]
DC	=	Direct Current [A]
e_x	=	Transformer Impedance [%]
H_c	=	Harmonic Constant [%]
I_{FL}	=	Full Load Current on Transformer [A]
I_{SC}	=	Short Circuit Current of Transformer [A]
P_E	=	Iron Loss Factor of Transformer []
P_{VFD}	=	Active Power of Drive Load [kW]
PWHD	=	Partial Weighted Harmonic Distortion
S_{NOM}	=	Transformer Nominal Apparent Power [kVA]
S_{SC}	=	Short Circuit Apparent Power of Transformer [MVA]
S_{VFD}	=	Drive Apparent Power [kVA]
THCD	=	Total Harmonic Current Distortion [%]
THD	=	Total Harmonic Distortion [%]
THVD	=	Total Harmonic Voltage Distortion [%]



Wallace Eannace Associates, Inc.

**50 New Town Road
Plainview, NY 11803
Tel: 516-454-9300
Fax: 516-454-9307**

**779 Susquehanna Avenue
Franklin Lakes, NJ 07417
Tel: 201-891-9550
Fax: 201-891-4298**

