

## Improving VAV Ventilation Systems

VL<sup>T</sup>® 6000 HVAC

### ■ The Application

VAV or Variable Air Volume systems, are used to control both the ventilation and temperature to satisfy the requirements of a building. Central VAV systems are considered to be the most energy efficient method to air condition buildings. By designing central systems instead of distributed systems, a greater efficiency can be obtained.

The efficiency comes from utilizing larger fans and larger chillers which have much higher efficiencies than small motors and distributed air-cooled chillers. Savings are also seen from the decreased maintenance requirements.

### ■ The traditional design:

VAV systems typically bring outside air into Air Handling Units (AHU) where the air temperature and humidity can be adjusted. Central fans blow the air across cooling and heating coils into ductwork which distributes the air throughout the building to all the individual zones. The air passes into each zone from the ductwork through individual VAV boxes. A temperature sensor located in each zone is connected to its VAV box and opens or closes the VAV box to maintain the defined temperature setpoint. As the zone becomes satisfied, the VAV box modulates to a closed position. As the zone's requirements become satisfied, the pressure in the ductwork begins to rise as the openings in the ductwork close.

Traditionally, inlet dampers, discharge dampers or Inlet Guide Vanes are installed in the air handling units to prevent this over pressurization and save energy. These devices work by creating resistance and a pressure drop to the air entering the ductwork or reducing the efficiency of the fan. The more the VAV boxes in the system close, the more the dampers close to maintain a constant static duct pressure. The dampers or IGVs for both the supply and return fan are commonly controlled by a controller maintaining a fixed pressure in the supply ductwork downstream of the AHU and a fixed differential air flow between the supply and return systems.

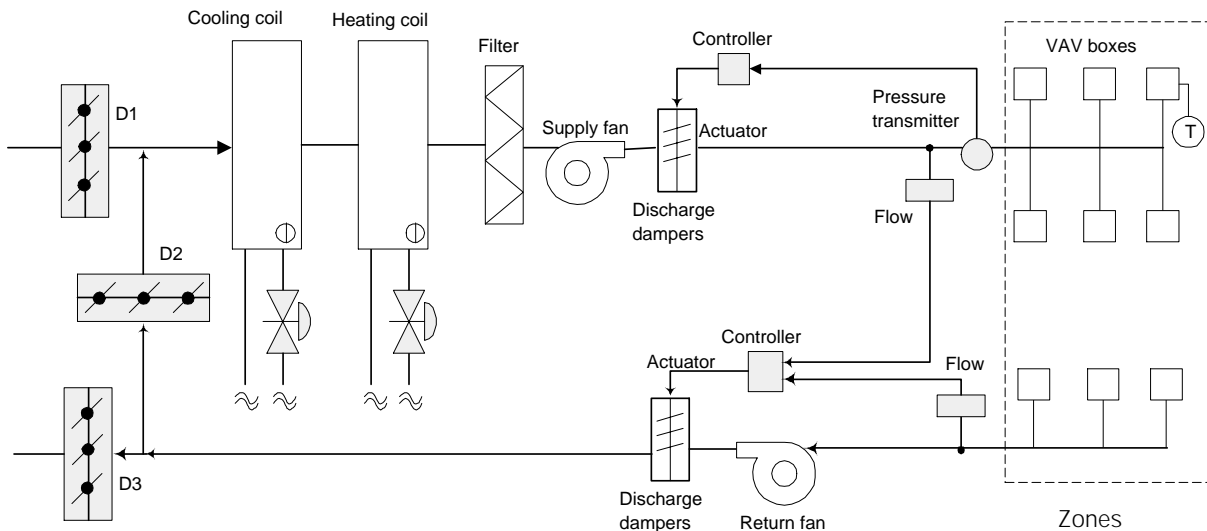

Fig. 1  
Traditional Ventilation system

■ The new standard

While dampers and IGVs work to maintain a constant pressure in the ductwork, a VLT frequency converter solution saves much more energy and reduces the complexity of the installation. Instead of creating an artificial pressure drop or causing a decrease in fan efficiency, the VLT frequency converter decreases the speed of the fan to provide the flow and pressure required by the system.

Centrifugal devices such as fans behave according to the centrifugal affinity laws. This means the fans decrease the pressure and flow they produce as their speed is reduced. Their power consumption is thereby significantly reduced.

The return fan is frequently controlled to maintain a fixed difference in airflow between the supply and return. The advanced PID controller of the VLT 6000 HVAC can be used to eliminate the need for additional controllers.

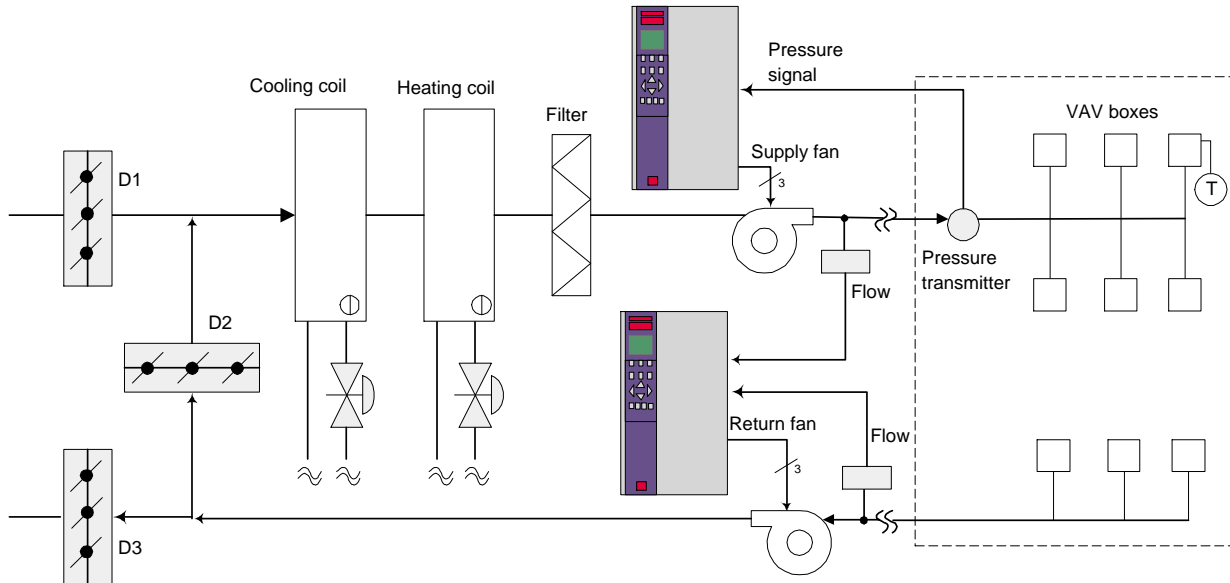

Fig. 2  
The VLT frequency converter solution

Figure 3 graphically shows the difference between operating at constant speed with a discharge damper and operating with a variable frequency drive. Design operation, point A, is only necessary a small percentage of the time, the majority of the time the flow rate required is lower depending on the load profile of the building. As the system's flow rate requirements decrease to flow 2, at constant speed the system curve moves up the fan curve to point B. The pressure generated by the fan at this operation point, P2, is more than the system requires and the difference must be absorbed by the dampers. At variable speed operation, the fan curve moves along the system curve. The new operating point C is established. The pressure P3 is now generated which is what is required by the system. Since the power consumed by the fan equals the flow times the pressure divided by the fan efficiency, the pressure difference between points B and C results in proportional energy savings.

As a side benefit, the efficiency of the fan remains high when using variable speed drives and decreases when using discharge dampers or inlet guide vanes resulting in additional savings.

$$\text{Power} = \frac{\text{Flow} \times \text{Pressure}}{\text{Fan eff.}} \quad [\text{kW}]$$

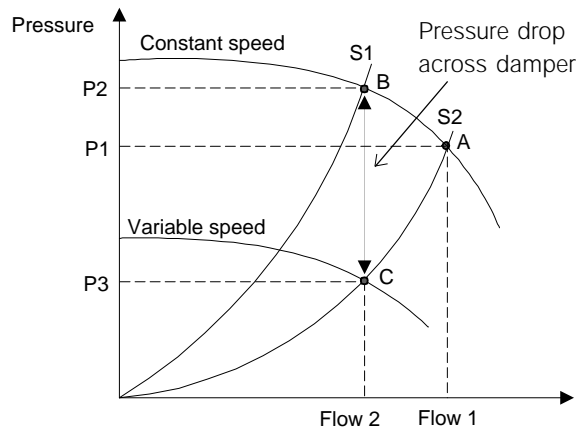

Fig. 3

■ **Specific energy consumption:**

Fig. 4 shows the specific energy consumption of several regulation methods for variable flow. Graph 1 shows the theoretical energy consumption according to the basic "Fan Laws", graph 2 the VLT solution, graph 3 and 4 are 2-speed motors (half/full speed, 2/3/full speed) with damper, graph 5 a fixed speed motor with Inlet Guide Vanes (IGV), graph 6 fixed speed motor with discharge damper. In any event VLT frequency converters is the most optimal solution.

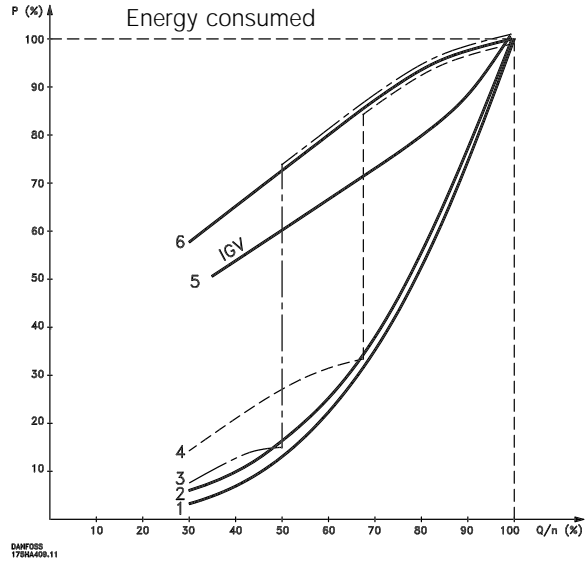

Fig. 4

■ **Annual operation load profile**

To calculate your potential savings, one must look at the actual load profile. The load profile indicates the amount of flow the system requires to satisfy its loads during the typical day or time period under study. Figure 5 shows a typical load profile for a VAV system. This profile will vary depending on the specific needs of each system due to location, safety margins used in the design phase and other factors, but is representative of normal systems.

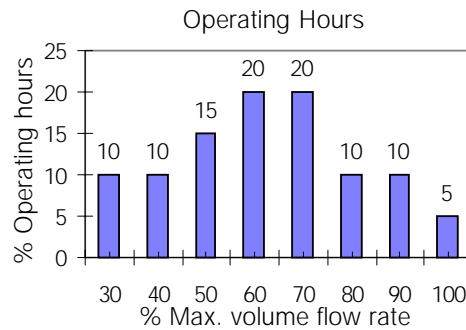

Figure 5

■ **Energy saving calculation example**

In the following calculation example a 30 kW fan is operated according to the load profile shown in fig. 4. The energy consumption during one year running time is calculated for an AHU comparing the VLT frequency converter solution with discharge damper and a 10% sensor setpoint. The result shows that 143624 kWh is saved in energy consumption using VLT 6000 HVAC.

Flow (%)	Hours (%)	Hours run	Power Consumption (kW)		Energy for 30 kW fan motor	
			Dampers	VLT 6000 HVAC	Dampers	VLT 6000 HVAC
30	10%	876	26	1	22768	1055
40	10%	876	26	3	22673	2249
50	15%	1314	26	5	34122	6077
60	20%	1752	26	8	45987	13169
70	20%	1752	27	11	46842	19990
80	10%	876	27	17	24059	14464
90	10%	876	28	23	24952	20224
100	5%	438	30	31	13235	13786
	100%	8760 Hours			234637 kWh	91013 kWh

Fig. 6

■ **Sensor Type And Placement**

The energy savings capabilities of a properly installed VLT frequency converter system is well known. However, the importance the sensor type and placement has on these calculations is often overlooked. To achieve the expected energy savings, it is critical that the sensors are placed properly in the system.

For VAV systems, a pressure sensor should be placed roughly 2/3 of the distance of the supply ductwork downstream of the supply fan. Placing the sensor downstream of the fan allows us to take advantage of the reduced resistance the ducts have at lower flow rates and allows us to maintain a lower setpoint value (see fig. 7b).

The goal of the fan system is to maintain the minimum required static pressure at the inlet of the VAV boxes. This allows the VAV boxes to operate properly and evenly distribute the air to the controlled zone. The fans discharge pressure requirement is calculated by adding the static pressure that is required for proper operation of the VAV boxes to the pressure drop expected in the ductwork. Then a safety margin is applied to compensate for any unforeseen design modifications required during installation.

When the static pressure sensor is placed directly after the discharge of the supply fan. Any oversizing of the fan can be eliminated and balancing of the system is simplified. However, in order to guarantee proper operation of the VAV boxes, the pressure drop in the duct during maximum flow conditions

must be assumed requiring the pressure setpoint to be set equal to the design pressure of the fan (fig. 7a). The area between the control curve and the system curve represents the wasted energy. As air flow is reduced, the fan continues to produce this high pressure even though the pressure losses in the ducts have been greatly reduced. This results in more pressure being supplied to the VAV boxes than is necessary for proper operation. Some energy is saved with this technique, but the full energy saving potential is not realized. The over pressurization which occurs at low flow is the cause of the wasted energy.

When the static pressure sensor is placed roughly 2/3 downstream the system automatic compensation for the actual pressure drop in the duct occurs. As a result, the fan only produces the pressure that is required by the VAV boxes, regardless of the flow. This sensor placement optimizes energy savings.

Figure 7 shows the impact the sensor placement can have on energy savings. The lower the minimum setpoint, the slower the VLT frequency converter can run the fan saving increasing amounts of energy.

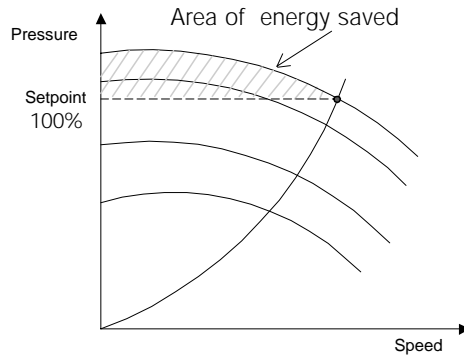
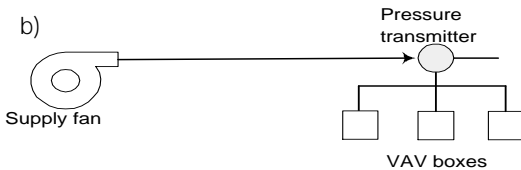
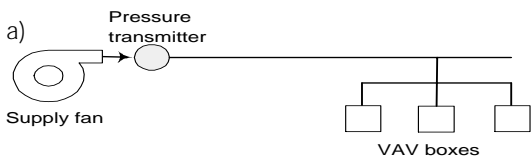

Energy consumption with 100% setpoint  
 Total energy consumption per year: 185581 kWh  
 Annual savings: (49056 x US\$ 0.10) US\$ 4906

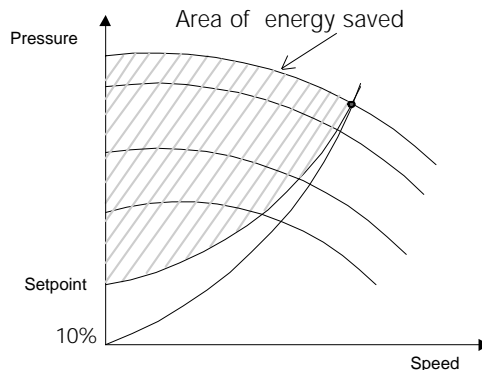

Energy consumption with 10% setpoint  
 Total energy consumption per year: 91013 kWh  
 Annual savings: (143624 x US\$ 0.10) US\$ 14362

Fig. 7



Danfoss can accept no responsibility for possible errors in catalogues, brochures and other printed material. Danfoss reserves the right to alter its products without notice. This also applies to products already on order provided that such alterations can be made without subsequential changes being necessary in specifications already agreed. All trademarks in this material are property of the respective companies. Danfoss and the Danfoss logotype are trademarks of Danfoss A/S. All rights reserved.



## **Wallace Eannace Associates, Inc.**

**50 New Town Road  
Plainview, NY 11803  
Tel: 516-454-9300  
Fax: 516-454-9307**

**779 Susquehanna Avenue  
Franklin Lakes, NJ 07417  
Tel: 201-891-9550  
Fax: 201-891-4298**

